

Impact of Manufacturing System Configuration on Performance

Yoram Koren (1), S. Jack Hu, Thomas W. Weber
The University of Michigan, USA
Received on January 7, 1998

Abstract:

Manufacturing systems can be designed in many configurations. Different configurations have profound impact on the performance of the system in terms of reliability and productivity, product quality, capacity scalability, and cost. This paper analyzes these performance measures for different system configurations assuming known machine level reliability and process capability.

Keywords: system, quality, productivity

1. Introduction:

Traditional manufacturing systems for medium and high volume production are designed as serial lines. That is, machines are linked together one after another with each machine performing part of the operations needed to complete the part. With a serial line there is only one part flow-path. Even though this type of systems are cost effective for medium or high volume production, they do not fit the new era of global competitiveness characterized by (i) large fluctuation in product demands, and (ii) increasing product variety. With a serial line configuration, in order to increase the volume of production, an entire new line has to be constructed, which will double the production capacity of the system. However, there is no guarantee that the manufacturer will be able to double the sale of the products, and in this case the extra capacity will not be fully utilized. Furthermore, the structure of the serial line fits the production of one product type and cannot efficiently handle product variety. In addition, a serial line has relatively low reliability since when one machine fails, the entire system fails. Therefore, there is a need for utilizing new configurations of manufacturing systems that can respond better to the changing market demands of the new era of global competitiveness.

Manufacturing systems can be designed in many configurations, e.g., serial, parallel, or hybrid configurations. A parallel configuration has multiple identical part flow paths. A hybrid configuration is a mix of serial and parallel configurations. Different configurations have profound impact not only on the adaptability to market demands, but also on reliability, productivity, product quality, and cost. It is important to understand this impact to properly select the configuration for optimal performance.

We have recently studied a case in industry where a manufacturer designed and built two production systems for machining the same product using the same type of CNC machines (see Fig.1). System I is designed by linking 18 machines in series with almost no buffers between machines. System II is designed with

three shorter, identical lines of six machines each. Because of the significantly low reliability of System I, it must be reconfigured in a way similar to System II to improve the productivity.

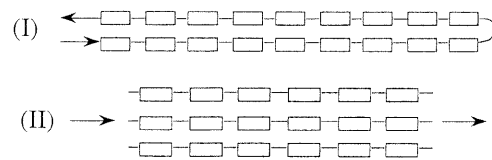

Fig. 1: Two different configurations used to machine the same product.

Given a certain number of machines, the number of possible configurations is very high. For example, with 4 machines there are 10 possible configurations; with 5 machines – 24 configurations. Each configuration affects the productivity and part quality, and requires a different investment cost as well as different expansion cost to allow incremental volume in production.

Very little work exists that systematically analyzes and compares manufacturing system configurations. Dashchenko (1991) described a CAD system for selecting optimal configurations for adjustable assembly lines in the automobile industry. Hassan (1994), in a survey article, recognized the significance of configuration on the throughput of a manufacturing system. Kaebnick et al (1996) developed an integrated approach for designing machine layout in cellular manufacturing systems. Hu (1997) analyzed how serial and parallel configurations in assembly affect product variation. However, there exists no method to systematically analyze the impact of the configurations. Usually quality and productivity are evaluated separately. This paper presents a set of new methodologies for systematically analyzing the performance of system configurations and comparing configuration alternatives. These methodologies enables manufacturers to select manufacturing configurations from a total system perspective. The approach of the paper is shown in Fig. 2.

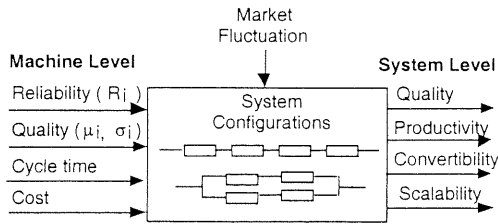

Fig. 2: Analysis approach.

2. Methodologies

When selecting a manufacturing system and its configurations, we are concerned with the following performance measures: (1) the system initial cost, (2) quality, (3) reliability and throughput, (4) scalability - cost of adding capacity to adapt to market demand, (5) the number of product types that the system can produce, and (6) the system conversion time between products. Analytical or computational tools are necessary to evaluate these performance measures.

We will start with the basic models of performance for a serial and a parallel system with two machines as shown in Fig. 3. Then, we will use six selected configurations with six machines to illustrate the analysis for more complex manufacturing system configurations (Fig. 4).

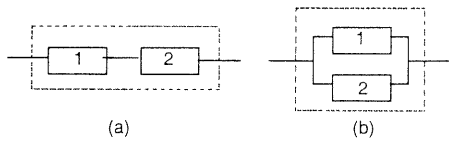

Fig. 3: Serial and parallel configurations with two machines.

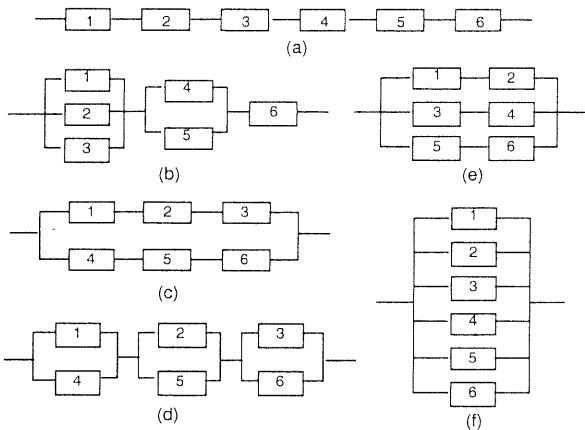

Fig. 4: Selected six configurations with six machines.

3.1 Quality

Quality has many meanings. Here we are mainly concerned with the dimensional quality of the machined or assembled products. We define quality as the deviation of a dimension from design intent. The closer a dimension is to the design intent, the better the quality. With volume production, the quality of the process can be measured by the mean deviation from the design intent \bar{y} , and the standard deviation σ_y from the mean. The second moment from the design intent, $\bar{y}^2 + \sigma_y^2$, can be used as a single measure of the total

variation by combining the mean deviation and standard deviation together. This definition is consistent with Taguchi's quality loss function definition. In physical unit, the square root, $\sqrt{\bar{y}^2 + \sigma_y^2}$, is used. Assume that the capability for each machine is given as (μ_i, σ_i^2) . For a serial configuration with two machines, if the operation in Machine 2 is dependent on that of Machine 1, then the resulting quality will be given as:

$$\sigma_y^2 = \sigma_1^2 + \sigma_2^2.$$

For a system with two machines in parallel, each machine will perform all the operations in a single setup. As a result, the variation for the parts from each machine will be smaller compared with that from a serial configuration. However, because of the two part flow paths, statistical "mixing" exists. As a result, the total variation from the parallel configuration could be larger, depending on the differences in the process means of the two parallel machines. The difference in quality between serial and parallel configurations with two machines are illustrated in Fig. 5.

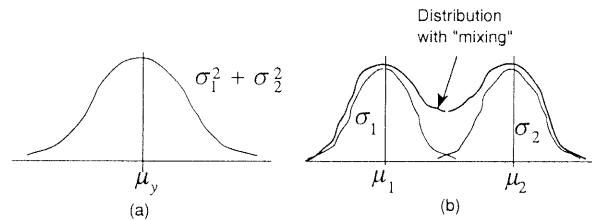

Fig 5: Dimensional variation of parts from (a) serial configuration, and (b) parallel configuration.

For the six configurations shown in Fig. 4, Monte Carlo simulation (Weber, 1997) is used to estimate the dimensional variation from each configuration. Assuming that each machine has a capability of setting the mean to within $\pm 10\mu$, and has a repeatability of 10μ (one std. dev.). The resulting dimensional variation for the six configurations are summarized in Fig. 6. As can be seen from this figure, configuration Fig. 4d has the largest quality variation because the number of part flow paths is the highest, 8. The serial line, i.e., configuration Fig. 4a, has the best quality because there is only one part flow path and no "mixing" exists.

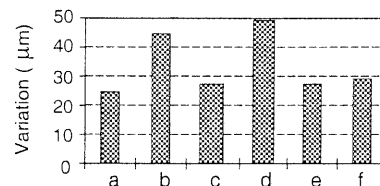

Fig. 6. Dimensional variation resulted from the six different configurations of Fig.4.

3.2 Reliability and productivity

The classical definition of reliability was developed for aerospace and electronic systems. It measures the probability of failure of the system. Similar definitions have been developed for manufacturing machines and equipment. A handbook developed by Society of Manufacturing Engineers and the National Center for

Manufacturing Sciences (1993) defines reliability of a machinery or equipment as the probability that the machinery/equipment can perform continuously, without failure, for a specified interval of time when operating under stated conditions.

This classical definition of reliability cannot be directly applied to manufacturing systems because in a parallel configuration, when one of the machine fails, the system can still function with 50% of the productivity assuming that the two machines perform identical functions with the same cycle time. Therefore, we introduce below the term "expected productivity" which accounts for the probability of failure and the corresponding productivity associated with each failure mode.

For a system with two machines, there are three modes of failure: no machine fails, one machine fails, and both machines fail. The probability and productivity associated with each failure mode in a serial and a parallel systems are shown in Table 1, where R_1 and R_2 are the reliability of machine 1 and 2 respectively.

Table 1: Failure modes and associated productivity for systems with two machines.

Failure Mode	Probability	Productivity	
		Serial	Parallel
No machine fails	$R_1 R_2$	1	1
Machine 1 fails	$R_2(1 - R_1)$	0	0.5
Machine 2 fails	$R_1(1 - R_2)$	0	0.5
Both machine fail	$(1 - R_1)(1 - R_2)$	0	0

Therefore, the expected productivity is the sum of the productivities weighted by the probabilities of the corresponding failure modes. For a serial system, the expected productivity is:

$$E[P] = 1 \cdot R_1 R_2 + 0 \cdot R_1(1 - R_2) + 0 \cdot R_2(1 - R_1) + 0 \cdot (1 - R_1)(1 - R_2) = R_1 R_2 \quad (1)$$

which is the same as the reliability of the system. For a parallel system, the expected productivity is

$$E[P] = 1 \cdot R_1 R_2 + 0.5 \cdot R_1(1 - R_2) + 0.5 \cdot R_2(1 - R_1) + 0 \cdot (1 - R_1)(1 - R_2) = 0.5R_1 + 0.5R_2 \quad (2)$$

which is a weighted sum of the reliabilities of the two machines.

Similar models can be developed for system configurations with three or more machines. The basic models with two machines, i.e., eq. (1) and (2), provide the basis for analyzing more complex system configurations. For the six configurations shown in Fig. 4, the reliability and expected productivity of these configurations are shown in Fig. 7.

3.3 Capacity Scalability

Capacity scalability is the ability to adjust the production capacity of a system in steps or stages. In order to adapt to fluctuations in product demand,

capacity must be adjusted quickly and cost-effectively. The initial configuration of the system has a profound effect on the system adjustment step-size and its cost. For example, if a serial line (Fig.4a) was originally built, and an increase in the production volume is needed to satisfy market demand, an entire new line has to be added, which will double the production capacity of the system. This addition will be expensive since there is no guarantee that the extra capacity will be fully utilized, which means a financial loss.

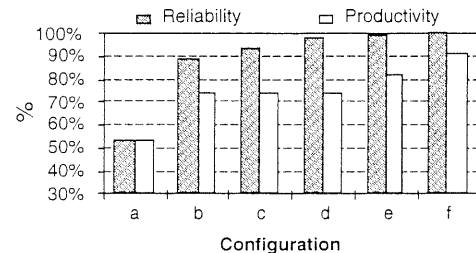

Figure 7. Reliability and expected productivity for the six configurations shown in Fig. 4.

The smallest adjustment steps can be done when the original system is pure parallel (e.g., Fig. 4f). However, the initial cost of a parallel system is the highest. In parallel configuration each machine must perform all operations on the product, and therefore each machine must have more tools and be able to perform more functions. As a result, the cost per additional volume is the highest with parallel configurations.

The configuration depicted in Fig. 4e might be a compromise. In this case, for example, if a product requires machining on both the upper and side surfaces, machines 1,3, and 5 might be 3-axis vertical milling machines, and machines 2, 4, and 6 might be 3-axis horizontal milling machines. Whereas, in this example, all six machines in the parallel system in Fig. 4f must be 5-axis milling machines – a system which is much more expensive. The drawback of the system in Fig. 4e is that capacity scalability could be performed in steps of 33.3% rather than steps of 16.6% as with the parallel configuration.

The steps of adding capacity in the configurations of Figs. 4c and 4d is even bigger – 50%. Figure 4b represents a case in which the steps are unequal: addition of 33.3% capacity requires three machines of type 1, 4, and 6; but the next additional 16.6% requires only addition of one machine of type 1, and therefore it is not expensive. This configuration will be applied in cases where machine 6 performs a special, short operation such as laser welding.

Of course, in each configuration theoretically the manufacturer can add one machine in parallel to any existing system, which makes the addition for all configurations equal. However, this is not recommended in practice since integration of a different-type, complex machine into a system that does not include such machines, increases the integration and maintenance costs, and may cause problems in obtaining the required part quality.

To compare the six configurations in Fig. 4, we made the cost assumptions summarized in Table 2, where the

base cost of the machines are all the same, \$100,000. But because of the different operations required with each machine, the tooling cost will be different. The result of the comparison is shown in Fig. 8. The X-axis shows the six configurations, the Y-axis shows the scale of adding capacity, and the Z-axis shows the corresponding cost for each step in the scale.

3. Selecting a System

In selecting a production system, the manufacturer has to take into account several considerations:

- The system initial cost,
- Quality – capability of the system in producing parts with small variation,
- Expected productivity which accounts for the reliability and productivity,
- Scalability – cost of adding capacity to adapt to market demand,
- Number of product-variations that the system can produce, and
- System conversion time between products.

Table 2: Initial system cost and cost of scalability (in \$1,000).

	Configuration					
	a	b	c	d	e	f
Cost / machine	100	100	100	100	100	100
Tooling cost per machine	5	15	20	20	25	35
Initial System Cost	630	690	720	720	750	810
Incremental Volume (%)	Cost					
16.6						135
33.3		345			250	270
50.0			360	360		405
66.6		575			500	540
83.3						675
100.0	630	690	720	720	750	810

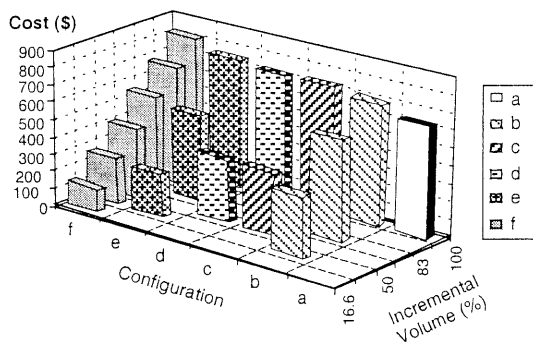

Fig. 8: System scalability, both resolution and cost.

Because of page limit of this paper we cannot thoroughly discuss the last two points. However, a serial system is ranked the lowest when considering these points – it can only produce one product at a time efficiently and it requires longer conversion time. The more that a system moves from serial towards parallel configuration - the better that it ranks on these two last points (Weber, 1997). However, as a system moves

toward parallel configurations, the system becomes more expensive.

For the above example, the preferred configurations are either this depicted in Fig. 4c or in 4e. Pure serial system has low reliability, and, in turn, low expected productivity, and it is not recommended. Pure parallel system is very expensive – both the initial cost and the cost for adding capacity. Configuration 4b might be selected only for special cases (e.g., that machine 6 performs a special, quick process). Configuration 4d does not have any advantage over 4c because it has similar reliability, expected productivity, scalability and initial cost, but it has a drawback – it produces larger part variation.

Therefore, if the system has to produce only one or two parts of the same family we recommend to select configuration 4c. If the number of parts is three or larger, we recommend selecting configuration 4e.

4. Conclusions

It has been shown that the configuration of the system has a profound effect on the performance of the system, including productivity, capacity scalability, and part quality. These performances will influence the life-cycle cost of the manufacturing system. This paper offers the system designer analytical tools to aid in the selection of the appropriate system configuration. Although the examples given in the paper are from the machining domain, the scope is quite general, and the methodology may be applied to other manufacturing domains.

Acknowledgment

The authors are pleased to acknowledge the financial support of the National Science Foundation (Grant # EEC-9529125).

References

- 1) Dashchenko, A. I., (1991), "Choice of Optimal Configurations for Flexible (Adjustable) Assembly Lines by Purposeful Search", *Annals of the CIRP*, Vol.40/1, 1991, pp. 13-16.
- 2) Hassan, M. M. D., (1994), "Machine Layout Problem in Modern Manufacturing Facilities", *Int. J. of Production Research*, Vol. 32, no. 11, pp2559-2584, Nov.
- 3) Hu, S. J., (1997), "Stream of Variation Theory for Automotive Body Assembly", *Annals of the CIRP*, Vol. 46/1, pp.1-6.
- 4) Kaebernicke, H. and Bazarqan-Lari, M, (1996), "An Integrated Approach to the Design of Cellular Manufacturing", *Annals of the CIRP*, Vol. 45/1, pp.421-425.
- 5) Society of Automotive Engineers, and National Center for Manufacturing Sciences, (1993), *Reliability and Maintainability Guideline for Manufacturing Machinery and Equipment*
- 6) Weber, W. T., (1997), *Impact of Manufacturing System Configuration on Performance*, D. Eng. Thesis, The University of Michigan.